

PRODUCT
NEWS

PN-E-010

NEW PRODUCT

NEW

 **DIJET**[®]

SHOULDER SIX

for high efficient shoulder milling with six corners

EXSIX Type

■ Facemill type: $\phi 50 \sim \phi 160$



DIJET GmbH • www.dijet.de

SHOULDER SIX

Features of product

Indexable shoulder milling cutter
"SHOULDER 6" EXSIX type
have high rigidity 6 corners insert.

● Feature of body

EXSIX have excellent chip removal rate and high rigidity body .

Max depth of cut (a_p)=10mm is possible,

EXSIX are useable for wide applications such as face milling, slotting and plunging.

Arc-geometry on the periphery cutting edge

Due to arc-geometry on the periphery cutting edge, cusp height can be smaller even in case of large a_p and achieve high efficient & high precision machining for vertical wall.

Positive axial rake angle

Due to unique 3D insert shape, axial rake angle is positive, therefore EXSIX achieve low cutting force.



Cutting force comparison

Small a_p cutting condition ($a_p=3\text{mm}$, $a_e=40\text{mm}$)

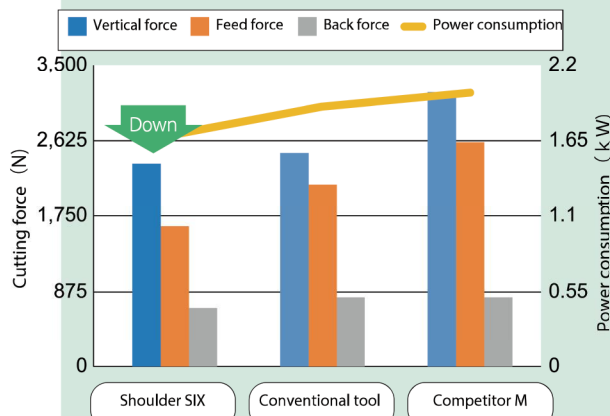

Large a_p cutting condition ($a_p=8\text{mm}$, $a_e=30\text{mm}$)

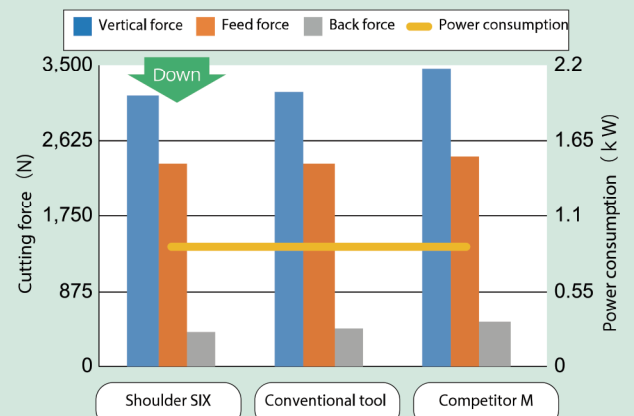

● Feature of insert



Economical double-side insert(6 corners).
7.5 mm thickness provides high rigidity,
enabling stable machining for roughing.
Corner R size is R0.8 & R1.6.

Insert grade <JC8050> for General steel and Mold steel less than 35HRC.

Insert grade <JC8118> for Cast iron and High hardened die steel less than 50HRC.



● Application

ISO	P				M				K			H					
	P01	P10	P20	P30	P40	M01	M10	M20	M30	M40	K01	K10	K20	K30	H01	H10	H20
Applicable range			JC8118					JC8118					JC8118				JC8118
				JC8050				JC8050									

Tool life comparison

Material : C50
● Tool dia. : $\phi 63$
● Cutting conditions : $N=910(\text{min}^{-1})$,
 $V_c=180(\text{m}/\text{min})$, $f_z=0.3\text{mm}/\text{t}$
Overhung length : $L=140\text{mm}$
Down cut

Achieved low cutting force under both cutting conditions. Especially at small ap cutting condition, cutting force is reduced more compared with the other cutters.

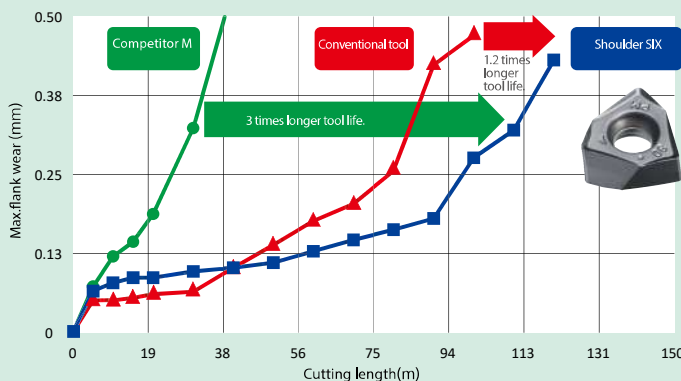

Material : P20
● Tool dia. : $\phi 63$
● Cutting conditions :
 $N=750(\text{min}^{-1})$,
 $V_c=148(\text{m}/\text{min})$,
 $f_z=0.3(\text{mm}/\text{t})$
Down cut

EXSIX achieved 3 times longer tool life compared with Competitor M, and 1.2 times longer compared with Conventional tool.

Cutting performance

Surface roughness comparison

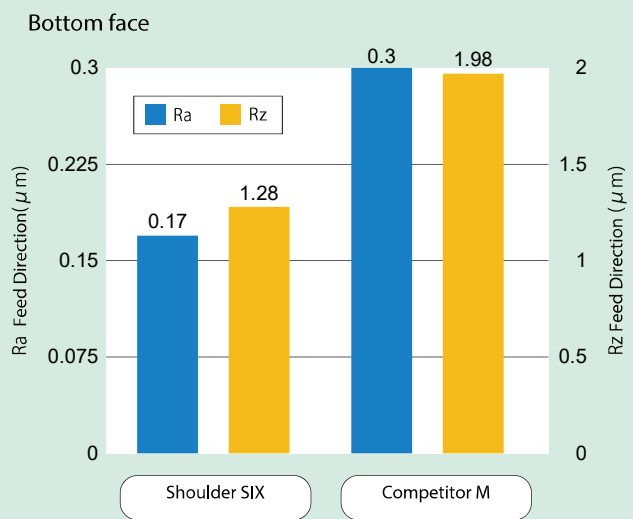
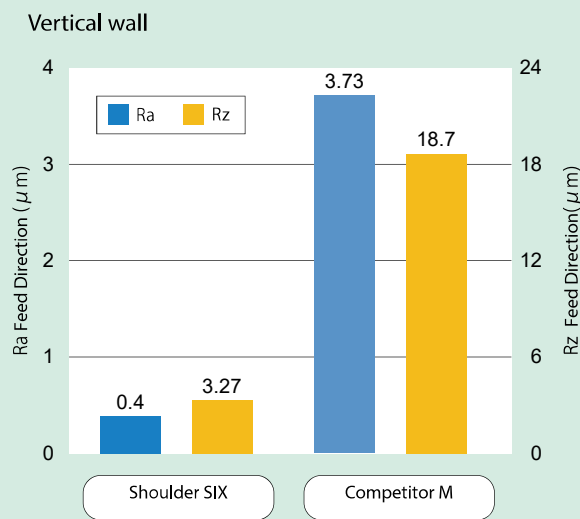

Achieve good surface roughness due to improved chip removal rate at vertical wall and bottom face machining.
In addition, achieved better surface roughness of bottom face by wiper cutting edge.

Material : C50

- Tool dia. : $\phi 63$
- Cutting conditions :
N=910(min^{-1}), Vc=180(m/min), fz=0.3(mm/t),
ap=3mm, ae=40mm
Down cut

Cutting accuracy comparison

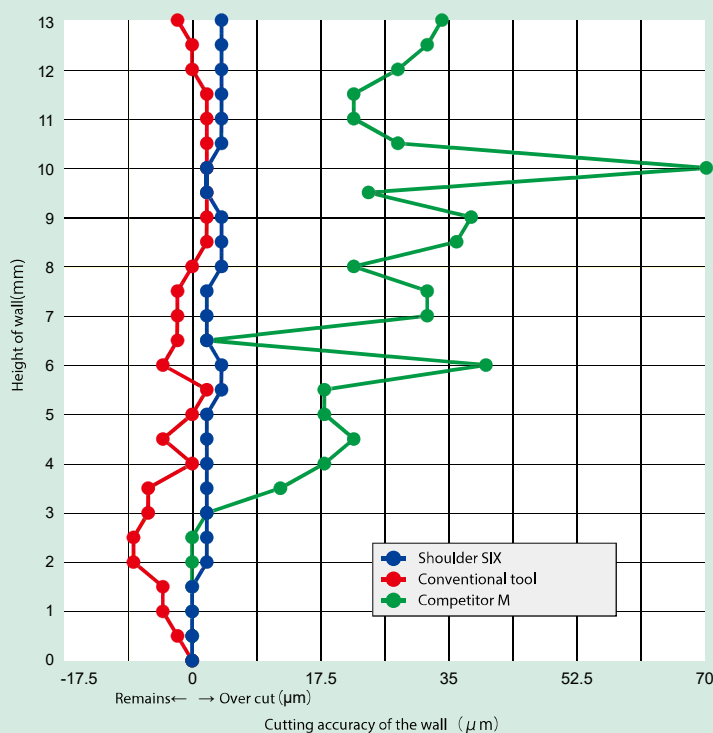

Material : C50

- $\phi 63$
Tool dia.
- Cutting conditions :
N=910(min^{-1}), Vc=180(m/min),
fz=0.3(mm/t), ap=3mm, ae=40mm
Down cut

Positive axial rake angle improved chip removal rate. Arc-geometry on the periphery cutting edge achieved high precision machining.

● Surface roughness comparison

Shoulder SIX

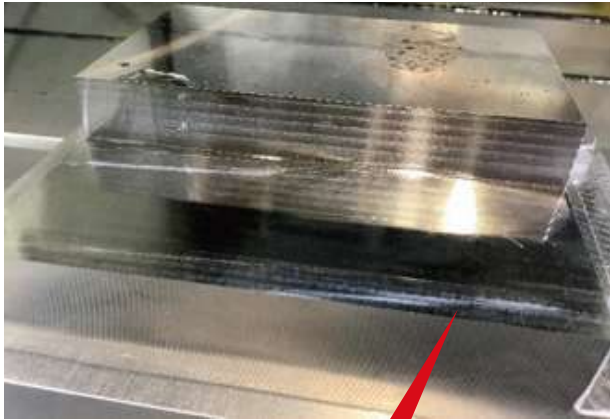

Good surface roughness!

Competitor M

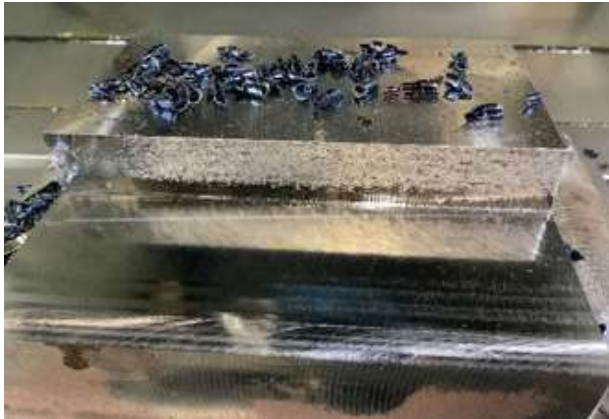

● Cutting data

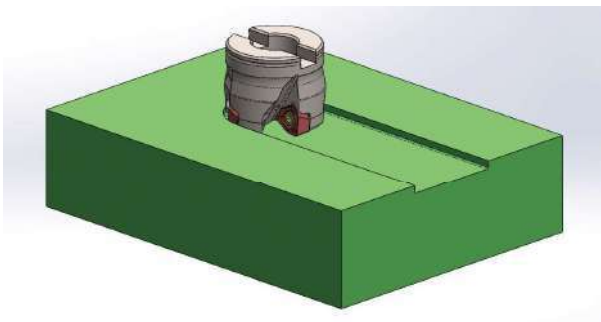

Result

Even in slotting, due to high rigidity, EXSIX achieved extremely excellent chip removal rate 160cm³/min.

Also EXSIX enable stable machining without damaging the insert and screws.

Work	Part name	Stamping die	
	Material	FC250	
	Hardness	—	
Tool	Tool No.	EXSIX-4050R-22	
	Insert No.	YCMU090708ZER-PM(JC8118)	
Cutting conditions	Spindle speed Cutting speed	n	800 (min ⁻¹)
		V_c	126 (m/min)
	Feed speed	V_f	800 (mm/min)
		f_z	0.25 (mm/t)
	a_p		4 (mm)
	a_e		50 (mm)
	Coolant		Air blow(internal)
Machine		Double column type MC	

SHOULDER SIX

Line up

● Facemill type

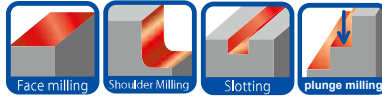

● Through coolant hole

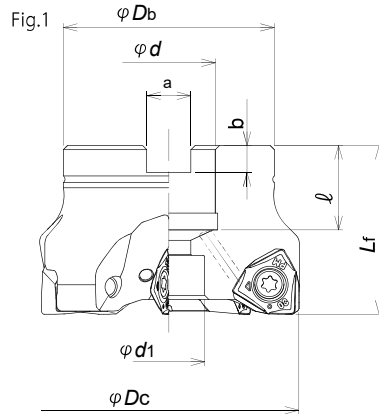

● Without coolant hole

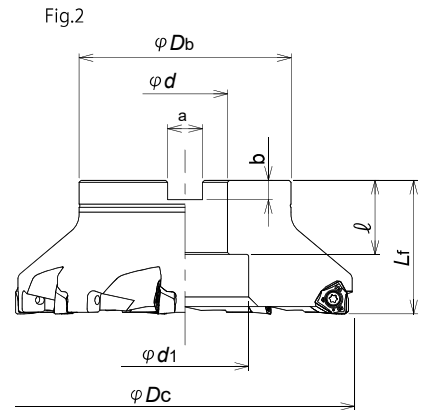

● Body

Type	Cat. No.	Stock	No. of inserts	(mm) Dimensions								Set bolt	(kg) Weight	Fig.	Applicable inserts	
				φDc	Lf	φDb	φd	$\varphi d1$	a	b	l					
Metric Bore	EXSIX-4050R-22	●	4	50	40	47	22	14	10.4	6.3	20	M10X1.5X25★	Head cap screw (Slim head)	0.33	1	YCMU0907**ZER-PM
	EXSIX-4052R-22	●	4	52	40	47	22	14	10.4	6.3	20	M10X1.5X25★		0.35	1	
	EXSIX-5063R-22	●	5	63	40	50	22	17	10.4	6.3	20	M10	Head cap screw (JIS standard)	0.50	1	
	EXSIX-5066R-22	●	5	66	40	50	22	17	10.4	6.3	20	M10		0.53	1	
	EXSIX-6080R-27	●	6	80	50	56	27	20	12.4	7	22	M12X1.75X30★		0.93	1	
	EXSIX-7100R-32	●	7	100	50	85	32	26	14.4	8	25	M16X2X30★		1.88	1	
	EXSIX-8125R-40	●	8	125	63	100	40	32	16.4	9	32	M20X2.5X40★		3.62	1	
	EXSIX-9160R-40	●	9	160	63	100	40	60	16.4	9	35	M20		4.67	2	

●: Standard stock items
 □: Stock in Japan. (10days delivery upon ordering)

Note) 1. All cutters are supplied without inserts.
 2. ★ mark shows: these cutter bodies are equipped with the set bolt because of the specified bolt size. Except for these cutter bodies, please use the set bolt equipped with arbor.
 3. All cutters are supplied without wrench & MOLY.

Parts	
Clamp screw	Wrench (not be included)
CSW-513H	A-20

Clamp screw	Recommended torque (N·m)
CSW-513H	5.5



● Insert

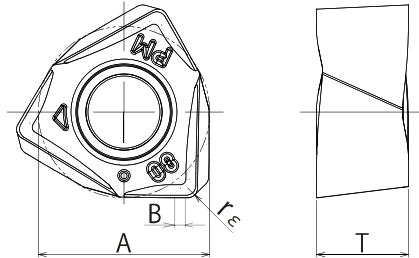

Cat. No.	Tolerance	PVD Coated		Dimensions (mm)			
		JC8050	JC8118	A	T	B	rε
YCMU090708ZER-PM	M	●	●	14	7.5	1.41	0.8
YCMU090716ZER-PM	M	●	●	14	7.5	0.62	1.6

● : Standard stock items
10 inserts per case.

● Discrimination of grade for insert.

Each grade shows discrimination mark on the insert surface.

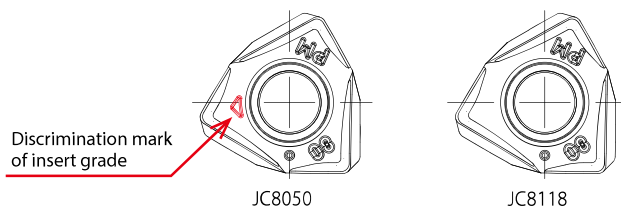

Recommended cutting conditions for shoulder milling

Facemill type

1/3

Work materials	Grades	Tool dia. (mm)									
		50/52					63/66				
		No. of teeth 4N					No. of teeth 5N				
		l (mm)	a_p (mm)	$a_p \times a_e$ (mm)	n (min ⁻¹)	V_f (mm/min)	l (mm)	a_p (mm)	$a_p \times a_e$ (mm)	n (min ⁻¹)	V_f (mm/min)
Carbon steel (C50, C55) Below 250HB	JC8050	~100	~9.0	~45	1,270	1,520	~100	~9.0	~45	1,010	1,770
		150	~8.0	~30	1,150	1,150	150	~8.0	~30	910	1,370
		200	~7.0	~20	1,020	820	200	~7.0	~20	810	1,010
Cast steel (1.7225) Below 285HB	JC8050	~100	~9.0	~45	1,150	1,380	~100	~9.0	~45	910	1,590
		150	~8.0	~30	1,020	1,020	150	~8.0	~30	810	1,220
		200	~7.0	~20	890	710	200	~7.0	~20	710	890
Die steel (1.2344, 1.2379) Below 255HB	JC8050	~100	~9.0	~45	1,270	1,520	~100	~9.0	~45	1,010	1,770
		150	~8.0	~30	1,150	1,150	150	~8.0	~30	910	1,370
		200	~7.0	~20	1,020	820	200	~7.0	~20	810	1,010
Mold steel (1.2311, P20) 30~36HRC	JC8118	~100	~9.0	~45	950	1,140	~100	~9.0	~45	760	1,330
		150	~8.0	~30	860	860	150	~8.0	~30	680	1,020
		200	~7.0	~20	760	610	200	~7.0	~20	610	760
Mold Steel (1.2311, P21) 38~43HRC	JC8118	~100	~9.0	~30	760	760	~100	~9.0	~30	610	760
		150	~8.0	~25	670	540	150	~8.0	~25	530	530
		200	~7.0	~15	570	340	200	~7.0	~15	450	340
Hardened die steel (1.2344, 1.2379) 42~52HRC	JC8118	~100	~9.0	~25	640	510	~100	~9.0	~25	510	510
		150	~8.0	~15	570	340	150	~8.0	~15	450	340
		200	~7.0	~8	510	200	200	~7.0	~8	400	200
Cast iron (GG25) 160~260HB	JC8118	~100	~9.0	~45	1,590	1,910	~100	~9.0	~45	1,260	2,210
		150	~8.0	~30	1,460	1,460	150	~8.0	~30	1,160	1,740
		200	~7.0	~20	1,340	1,070	200	~7.0	~20	1,060	1,330
Nodular cast iron (GGG70) 170~300HB	JC8118	~100	~9.0	~45	950	950	~100	~9.0	~45	760	1,140
		150	~8.0	~30	830	660	150	~8.0	~30	660	830
		200	~7.0	~20	700	420	200	~7.0	~20	560	560
Stainless steel Austenitic (AISI 304, 316, 317)	JC8050	~100	~9.0	~45	760	610	~100	~9.0	~45	610	610
		150	~8.0	~30	700	420	150	~8.0	~30	560	420
		200	~7.0	~20	640	260	200	~7.0	~20	510	260
Stainless steel Ferritics/Martensitic (AISI 403, 420J2, 430)	JC8118	~100	~9.0	~45	1,150	1,150	~100	~9.0	~45	910	1,370
		150	~8.0	~30	1,020	820	150	~8.0	~30	810	1,010
		200	~7.0	~20	890	530	200	~7.0	~20	710	710

l : Overhung length a_p : Axial depth of cut a_e : Radial depth of cut n : Spindle speed V_f : Feed speed

Note:

*1. The figure to be adjusted according to the machine rigidity or work rigidity.

*2. In case of chatter occurring, recommend to reduce the depth of cut a_p or Feed speed.

*3. If machine does not have enough power, recommend to reduce the depth of cut a_p or Spindle speed and Feed speed.

*4. Use air blow.

● Facemill type

2/3

Work materials	Grades	Tool dia. (mm)									
		80					100				
		No. of teeth 6N					No. of teeth 7N				
		l (mm)	a_p (mm)	$a_p \times a_e$ (mm)	n (min ⁻¹)	V_f (mm/min)	l (mm)	a_p (mm)	$a_p \times a_e$ (mm)	n (min ⁻¹)	V_f (mm/min)
Carbon steel (C50, C55) Below 250HB	JC8050	~100	~9.0	~45	800	1,680	~100	~9.0	~45	640	1,570
		150	~8.0	~30	720	1,300	150	~8.0	~30	570	1,200
		200	~7.0	~20	640	960	200	~7.0	~20	510	890
Cast steel (1.7225) Below 285HB	JC8050	~100	~9.0	~45	720	1,510	~100	~9.0	~45	570	1,400
		150	~8.0	~30	640	1,150	150	~8.0	~30	510	1,070
		200	~7.0	~20	560	840	200	~7.0	~20	450	790
Die steel (1.2344, 1.2379) Below 255HB	JC8050	~100	~9.0	~45	800	1,680	~100	~9.0	~45	640	1,570
		150	~8.0	~30	720	1,300	150	~8.0	~30	570	1,200
		200	~7.0	~20	640	960	200	~7.0	~20	510	890
Mold steel (1.2311, P20) 30~36HRC	JC8118	~100	~9.0	~45	600	1,260	~100	~9.0	~45	480	1,180
		150	~8.0	~30	540	970	150	~8.0	~30	430	900
		200	~7.0	~20	480	720	200	~7.0	~20	380	670
Mold Steel (1.2311, P21) 38~43HRC	JC8118	~100	~9.0	~30	480	720	~100	~9.0	~30	380	670
		150	~8.0	~25	420	500	150	~8.0	~25	330	460
		200	~7.0	~15	360	320	200	~7.0	~15	290	300
Hardened die steel (1.2344, 1.2379) 42~52HRC	JC8118	~100	~9.0	~25	400	480	~100	~9.0	~25	320	450
		150	~8.0	~15	360	320	150	~8.0	~15	290	300
		200	~7.0	~8	320	190	200	~7.0	~8	250	180
Cast iron (GG25) 160~260HB	JC8118	~100	~9.0	~45	990	2,080	~100	~9.0	~45	800	1,960
		150	~8.0	~30	920	1,660	150	~8.0	~30	730	1,530
		200	~7.0	~20	840	1,260	200	~7.0	~20	670	1,170
Nodular cast iron (GGG70) 170~300HB	JC8118	~100	~9.0	~45	600	1,080	~100	~9.0	~45	480	1,010
		150	~8.0	~30	520	780	150	~8.0	~30	410	720
		200	~7.0	~20	440	530	200	~7.0	~20	350	490
Stainless steel Austenitic (AISI 304, 316, 317)	JC8050	~100	~9.0	~45	480	580	~100	~9.0	~45	380	530
		150	~8.0	~30	440	400	150	~8.0	~30	350	370
		200	~7.0	~20	400	240	200	~7.0	~20	320	220
Stainless steel Ferritics/Martensitic (AISI 403, 420J2, 430)	JC8118	~100	~9.0	~45	720	1,300	~100	~9.0	~45	570	1,200
		150	~8.0	~30	640	960	150	~8.0	~30	510	890
		200	~7.0	~20	560	670	200	~7.0	~20	450	630

l : Overhung length a_p : Axial depth of cut a_e : Radial depth of cut n : Spindle speed V_f : Feed speed

Note:

*1. The figure to be adjusted according to the machine rigidity or work rigidity.

*2. In case of chatter occurring, recommend to reduce the depth of cut a_p or Feed speed.

*3. If machine does not have enough power, recommend to reduce the depth of cut a_p or Spindle speed and Feed speed.

*4. Use air blow.

Recommended cutting conditions for shoulder milling

Facemill type

3/3

Work materials	Grades	Tool dia. (mm)									
		125					160				
		No. of teeth 8N					No. of teeth 9N				
		l (mm)	a_p (mm)	$a_p \times a_e$ (mm)	n (min ⁻¹)	V_f (mm/min)	l (mm)	a_p (mm)	$a_p \times a_e$ (mm)	n (min ⁻¹)	V_f (mm/min)
Carbon steel (C50, C55) Below 250HB	JC8050	~100	~9.0	~45	510	1,430	~100	~9.0	~45	400	1,260
		150	~8.0	~30	460	1,100	150	~8.0	~30	360	970
		200	~7.0	~20	410	820	200	~7.0	~20	320	720
Cast steel (1.7225) Below 285HB	JC8050	~100	~9.0	~45	460	1,290	~100	~9.0	~45	360	1,130
		150	~8.0	~30	410	980	150	~8.0	~30	320	860
		200	~7.0	~20	360	720	200	~7.0	~20	280	630
Die steel (1.2344, 1.2379) Below 255HB	JC8050	~100	~9.0	~45	510	1,430	~100	~9.0	~45	400	1,260
		150	~8.0	~30	460	1,100	150	~8.0	~30	360	970
		200	~7.0	~20	410	820	200	~7.0	~20	320	720
Mold steel (1.2311, P20) 30~36HRC	JC8118	~100	~9.0	~45	380	1,060	~100	~9.0	~45	300	950
		150	~8.0	~30	340	820	150	~8.0	~30	270	730
		200	~7.0	~20	310	620	200	~7.0	~20	240	540
Mold Steel (1.2311, P21) 38~43HRC	JC8118	~100	~9.0	~30	310	620	~100	~9.0	~30	240	540
		150	~8.0	~25	270	430	150	~8.0	~25	210	380
		200	~7.0	~15	230	280	200	~7.0	~15	180	240
Hardened die steel (1.2344, 1.2379) 42~52HRC	JC8118	~100	~9.0	~25	250	400	~100	~9.0	~25	200	360
		150	~8.0	~15	230	280	150	~8.0	~15	180	240
		200	~7.0	~8	200	160	200	~7.0	~8	160	140
Cast iron (GG25) 160~260HB	JC8118	~100	~9.0	~45	640	1,790	~100	~9.0	~45	500	1,580
		150	~8.0	~30	590	1,420	150	~8.0	~30	460	1,240
		200	~7.0	~20	530	1,060	200	~7.0	~20	420	950
Nodular cast iron (GGG70) 170~300HB	JC8118	~100	~9.0	~45	380	910	~100	~9.0	~45	300	810
		150	~8.0	~30	330	660	150	~8.0	~30	260	590
		200	~7.0	~20	280	450	200	~7.0	~20	220	400
Stainless steel Austenitic (AISI 304, 316, 317)	JC8050	~100	~9.0	~45	310	500	~100	~9.0	~45	240	430
		150	~8.0	~30	280	340	150	~8.0	~30	220	300
		200	~7.0	~20	250	200	200	~7.0	~20	200	180
Stainless steel Ferritics/Martensitic (AISI 403, 420J2, 430)	JC8118	~100	~9.0	~45	460	1,100	~100	~9.0	~45	360	970
		150	~8.0	~30	410	820	150	~8.0	~30	320	720
		200	~7.0	~20	360	580	200	~7.0	~20	280	500

l : Overhung length a_p : Axial depth of cut a_e : Radial depth of cut n : S V_f :

Note:

- *1. The figure to be adjusted according to the machine rigidity or work rigidity.
- *2. In case of chatter occurring, recommend to reduce the depth of cut a_p or Feed speed.
- *3. If machine does not have enough power, recommend to reduce the depth of cut a_p or Spindle speed and Feed speed.
- *4. Use air blow.

Recommended cutting conditions for face milling

● Facemill type

1/3

Work materials	Grades	Tool dia. (mm)									
		50/52					63/66				
		No. of teeth 4N					No. of teeth 5N				
		l (mm)	a_p (mm)	a_e (mm)	n (min ⁻¹)	V_f (mm/min)	l (mm)	a_p (mm)	a_e (mm)	n (min ⁻¹)	V_f (mm/min)
Carbon steel (C50, C55) Below 250HB	JC8050	~150	~4.0	~1.0Dc	950	1,140	~150	~4.0	~1.0Dc	760	1,330
		200	~3.0	~40	830	830	200	~3.0	~55	660	990
		300	~2.0	~30	700	560	300	~2.0	~40	560	700
Cast steel (1.7225) Below 285HB	JC8050	~150	~4.0	~1.0Dc	950	1,140	~150	~4.0	~1.0Dc	760	1,330
		200	~3.0	~40	830	830	200	~3.0	~55	660	990
		300	~2.0	~30	700	560	300	~2.0	~40	560	700
Die steel (1.2344, 1.2379) Below 255HB	JC8050	~150	~4.0	~1.0Dc	950	950	~150	~4.0	~1.0Dc	760	1,140
		200	~3.0	~40	830	660	200	~3.0	~55	660	830
		300	~2.0	~30	700	420	300	~2.0	~40	560	560
Mold steel (1.2311, P20) 30~36HRC	JC8118	~150	~4.0	~1.0Dc	830	830	~150	~4.0	~1.0Dc	660	990
		200	~3.0	~40	760	610	200	~3.0	~55	610	760
		300	~2.0	~30	700	420	300	~2.0	~40	560	560
Mold Steel (1.2311, P21) 38~43HRC	JC8118	~150	~3.0	~1.0Dc	700	700	~150	~3.0	~1.0Dc	560	700
		200	~2.5	~40	640	510	200	~2.5	~55	510	510
		300	~1.5	~30	570	340	300	~1.5	~40	450	340
Hardened die steel (1.2344, 1.2379) 42~52HRC	JC8118	~150	~2.5	~40	570	460	~150	~2.5	~55	450	450
		200	~2.0	~30	510	310	200	~2.0	~40	400	300
		300	~1.5	~20	450	180	300	~1.5	~32	350	180
Cast iron (GG25) 160~260HB	JC8118	~150	~6.0	~1.0Dc	1,150	1,380	~150	~6.0	~1.0Dc	910	1,590
		200	~4.0	~40	950	950	200	~4.0	~55	760	1,140
		300	~2.0	~30	830	660	300	~2.0	~40	660	830
Nodular cast iron (GGG70) 170~300HB	JC8118	~150	~4.0	~1.0Dc	830	830	~150	~4.0	~1.0Dc	660	990
		200	~3.0	~40	760	610	200	~3.0	~55	610	760
		300	~2.0	~30	700	420	300	~2.0	~40	560	560
Stainless steel Austenitic (AISI 304, 316, 317)	JC8050	~150	~4.0	~40	700	560	~150	~4.0	~55	560	560
		200	~3.0	~30	640	380	200	~3.0	~40	510	380
		300	~2.0	~20	570	230	300	~2.0	~32	450	230
Stainless steel Ferritics/Martensitic (AISI 403, 420J2, 430)	JC8118	~150	~4.0	~1.0Dc	950	950	~150	~4.0	~1.0Dc	760	1,140
		200	~3.0	~40	830	660	200	~3.0	~55	660	830
		300	~2.0	~30	700	420	300	~2.0	~40	560	560

l : Overhung length a_p : Axial depth of cut a_e : Radial depth of cut n : Spindle speed V_f : Feed speed

Note:

- *1. The figure to be adjusted according to the machine rigidity or work rigidity.
- *2. In case of chatter occurring, recommend to reduce the depth of cut a_p or Feed speed.
- *3. If machine does not have enough power, recommend to reduce the depth of cut a_p or Spindle speed and Feed speed.
- *4. Use air blow.
- *5. In case of slotting, reduce Feed speed (V_f) to 50% or below of the above date.
- *6. Ramping & helical interpolation is not recommended.

Recommended cutting conditions for face milling

Facemill type

2/3

Work materials	Grades	Tool dia. (mm)									
		80					100				
		No. of teeth 6N					No. of teeth 7N				
		l (mm)	a_p (mm)	a_e (mm)	n (min ⁻¹)	V_f (mm/min)	l (mm)	a_p (mm)	a_e (mm)	n (min ⁻¹)	V_f (mm/min)
Carbon steel (C50, C55) Below 250HB	JC8050	~150	~4.0	~80	600	1,260	~150	~4.0	~100	480	1,010
		200	~3.0	~65	520	940	200	~3.0	~80	410	720
		300	~2.0	~50	440	660	300	~2.0	~60	350	490
Cast steel (1.7225) Below 285HB	JC8050	~150	~4.0	~80	600	1,260	~150	~4.0	~100	480	1,010
		200	~3.0	~65	520	940	200	~3.0	~80	410	720
		300	~2.0	~50	440	660	300	~2.0	~60	350	490
Die steel (1.2344, 1.2379) Below 255HB	JC8050	~150	~4.0	~80	600	1,080	~150	~4.0	~100	480	840
		200	~3.0	~65	520	780	200	~3.0	~80	410	570
		300	~2.0	~50	440	530	300	~2.0	~60	350	370
Mold steel (1.2311, P20) 30~36HRC	JC8118	~150	~4.0	~80	520	940	~150	~4.0	~100	410	720
		200	~3.0	~65	480	720	200	~3.0	~80	380	530
		300	~2.0	~50	440	530	300	~2.0	~60	350	370
Mold Steel (1.2311, P21) 38~43HRC	JC8118	~150	~3.0	~80	440	660	~150	~3.0	~100	350	490
		200	~2.5	~65	400	480	200	~2.5	~80	320	340
		300	~1.5	~50	360	320	300	~1.5	~60	290	200
Hardened die steel (1.2344, 1.2379) 42~52HRC	JC8118	~150	~2.5	~65	360	430	~150	~2.5	~80	290	300
		200	~2.0	~50	320	290	200	~2.0	~60	250	180
		300	~1.5	~35	280	170	300	~1.5	~40	220	150
Cast iron (GG25) 160~260HB	JC8118	~150	~6.0	~80	720	1,510	~150	~6.0	~100	570	1,200
		200	~4.0	~65	600	1,080	200	~4.0	~80	480	840
		300	~2.0	~50	520	780	300	~2.0	~60	410	570
Nodular cast iron (GGG70) 170~300HB	JC8118	~150	~4.0	~80	520	940	~150	~4.0	~100	410	720
		200	~3.0	~65	480	720	200	~3.0	~80	380	530
		300	~2.0	~50	440	530	300	~2.0	~60	350	370
Stainless steel Austenitic (AISI 304, 316, 317)	JC8050	~150	~4.0	~65	440	530	~150	~4.0	~80	350	370
		200	~3.0	~50	400	360	200	~3.0	~60	320	220
		300	~2.0	~35	360	220	300	~2.0	~40	290	200
Stainless steel Ferritics/Martensitic (AISI 403, 420J2, 430)	JC8118	~150	~4.0	~80	600	1,080	~150	~4.0	~100	480	840
		200	~3.0	~65	520	780	200	~3.0	~80	410	570
		300	~2.0	~50	440	530	300	~2.0	~60	350	370

l : Overhung length a_p : Axial depth of cut a_e : Radial depth of cut n : Spindle speed V_f : Feed speed

Note:

- *1. The figure to be adjusted according to the machine rigidity or work rigidity.
- *2. In case of chatter occurring, recommend to reduce the depth of cut a_p or Feed speed.
- *3. If machine does not have enough power, recommend to reduce the depth of cut a_p or Spindle speed and Feed speed.
- *4. Use air blow.
- *5. In case of slotting, reduce Feed speed (V_f) to 50% or below of the above date.
- *6. Ramping & helical interpolation is not recommended.

Facemill type

3/3

Work materials	Grades	Tool dia. (mm)									
		125					160				
		No. of teeth 8N					No. of teeth 9N				
		l (mm)	a_p (mm)	a_e (mm)	n (min ⁻¹)	V_f (mm/min)	l (mm)	a_p (mm)	a_e (mm)	n (min ⁻¹)	V_f (mm/min)
Carbon steel (C50, C55) Below 250HB	JC8050	~150	~4.0	~125	380	910	~150	~4.0	~160	300	810
		200	~3.0	~100	330	660	200	~3.0	~130	260	590
		300	~2.0	~75	280	450	300	~2.0	~95	220	400
Cast steel (1.7225) Below 285HB	JC8050	~150	~4.0	~125	380	910	~150	~4.0	~160	300	810
		200	~3.0	~100	330	660	200	~3.0	~130	260	590
		300	~2.0	~75	280	450	300	~2.0	~95	220	400
Die steel (1.2344, 1.2379) Below 255HB	JC8050	~150	~4.0	~125	380	760	~150	~4.0	~160	300	680
		200	~3.0	~100	330	530	200	~3.0	~130	260	470
		300	~2.0	~75	280	340	300	~2.0	~95	220	300
Mold steel (1.2311, P20) 30~36HRC	JC8118	~150	~4.0	~125	330	660	~150	~4.0	~160	260	590
		200	~3.0	~100	310	500	200	~3.0	~130	240	430
		300	~2.0	~75	280	340	300	~2.0	~95	220	300
Mold Steel (1.2311, P21) 38~43HRC	JC8118	~150	~3.0	~125	280	450	~150	~3.0	~160	220	400
		200	~2.5	~100	250	300	200	~2.5	~130	200	270
		300	~1.5	~75	230	180	300	~1.5	~95	180	160
Hardened die steel (1.2344, 1.2379) 42~52HRC	JC8118	~150	~2.5	~100	230	280	~150	~2.5	~130	180	240
		200	~2.0	~75	200	160	200	~2.0	~95	160	140
		300	~1.5	~50	180	140	300	~1.5	~60	140	130
Cast iron (GG25) 160~260HB	JC8118	~150	~6.0	~125	460	1,100	~150	~6.0	~160	360	970
		200	~4.0	~100	380	760	200	~4.0	~130	300	680
		300	~2.0	~75	330	530	300	~2.0	~95	260	470
Nodular cast iron (GGG70) 170~300HB	JC8118	~150	~4.0	~125	330	660	~150	~4.0	~160	260	590
		200	~3.0	~100	310	500	200	~3.0	~130	240	430
		300	~2.0	~75	280	340	300	~2.0	~95	220	300
Stainless steel Austenitic (AISI 304, 316, 317)	JC8050	~150	~4.0	~100	280	340	~150	~4.0	~130	220	300
		200	~3.0	~75	250	200	200	~3.0	~95	200	180
		300	~2.0	~50	230	180	300	~2.0	~60	180	160
Stainless steel Ferritics/Martensitic (AISI 403, 420J2, 430)	JC8118	~150	~4.0	~125	380	760	~150	~4.0	~160	300	680
		200	~3.0	~100	330	530	200	~3.0	~130	260	470
		300	~2.0	~75	280	340	300	~2.0	~95	220	300

l : Overhung length a_p : Axial depth of cut a_e : Radial depth of cut n : Spindle speed V_f : Feed speed

Note:

- *1. The figure to be adjusted according to the machine rigidity or work rigidity.
- *2. In case of chatter occurring, recommend to reduce the depth of cut a_p or Feed speed.
- *3. If machine does not have enough power, recommend to reduce the depth of cut a_p or Spindle speed and Feed speed.
- *4. Use air blow.
- *5. In case of slotting, reduce Feed speed (V_f) to 50% or below of the above date.
- *6. Ramping & helical interpolation is not recommended.

Recommended cutting conditions for plunge milling

● Facemill type

Work materials	Grades	Cutting speed Vc (m/min)	Feed speed per one insert fz (mm/t)	Radial depth of cut ae (mm)	Pick feed Pf (mm)
Carbon steel (C50, C55) Below 250HB	JC8050	180	0.25	~5	~0.5Dc
Cast steel (1.7225) Below 285HB	JC8050	160	0.25	~5	~0.5Dc
Die steel (1.2344, 1.2379) Below 255HB	JC8050	180	0.2	~5	~0.5Dc
Mold steel (1.2311, P20) 30~36HRC	JC8118	130	0.2	~5	~0.5Dc
Mold Steel (1.2311, P21) 38~43HRC	JC8118	100	0.15	~5	~0.5Dc
Hardened die steel (1.2344, 1.2379) 42~52HRC	JC8118	90	0.1	~5	~0.5Dc
Cast iron (GG25) 160~260HB	JC8118	200	0.3	~5	~0.5Dc
Nodular cast iron (GGG70) 170~300HB	JC8118	130	0.2	~5	~0.5Dc
Stainless steel Austenitic (AISI 304, 316, 317)	JC8050	110	0.15	~5	~0.5Dc
Stainless steel Ferritic/Martensitic (AISI 403, 420J2, 430)	JC8118	160	0.2	~5	~0.5Dc

Note:

- *1. The figure to be adjusted according to the machine rigidity or work rigidity.
- *2. In case of chatter occurring, recommend to reduce the depth of cut ap or Feed speed.
- *3. If machine dose not have enough power, recommend to reduce the depth of cut ap or Spindle speed and Feed speed.
- *4. Use air blow.

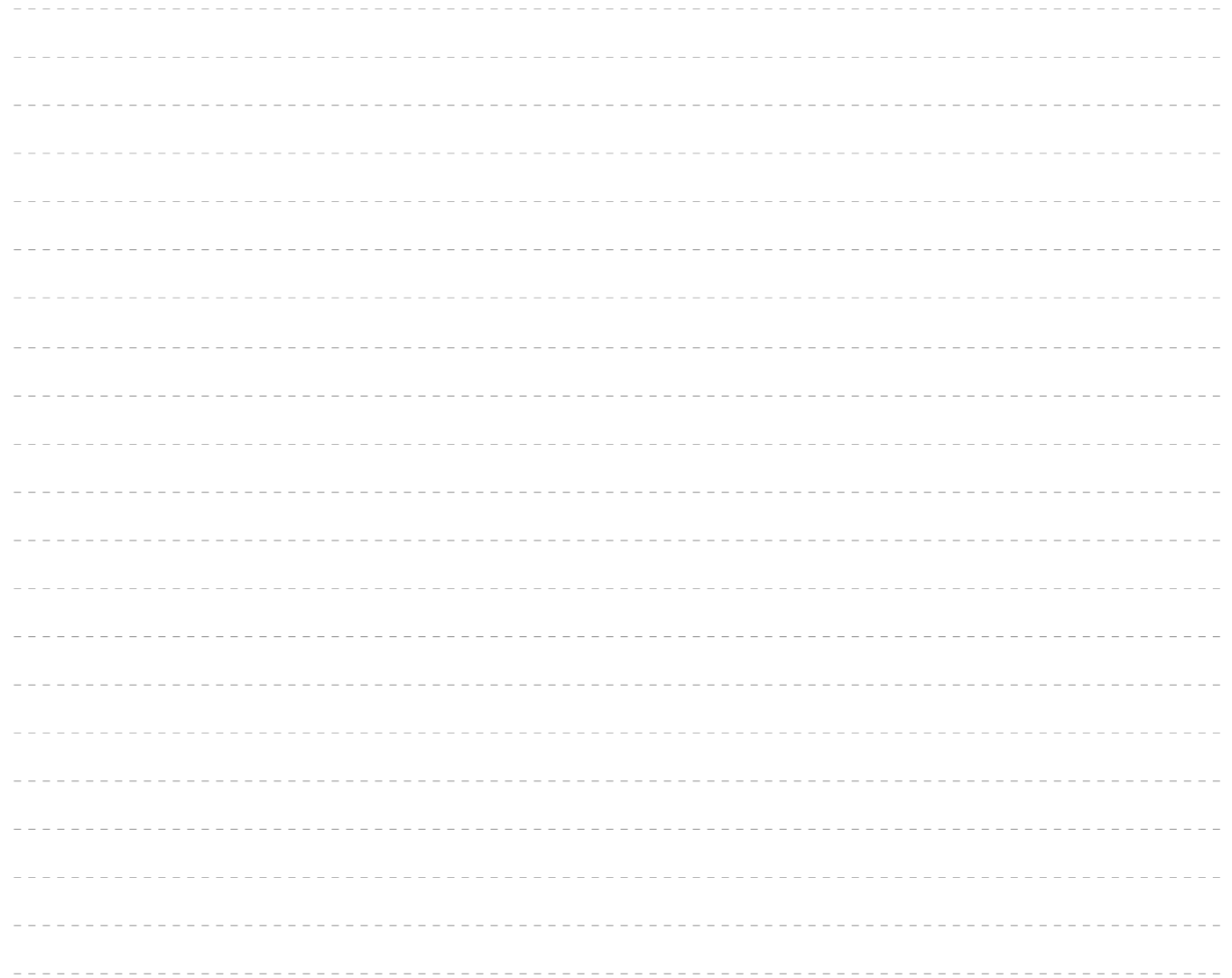

SHOULDER SIX
for high efficient shoulder milling with six corners

EXSIX Type





HEADQUARTER

DIJET Industrial Co.Ltd.

1-1-18, Kami-Higashi,

Hirano-ku, Osaka 547-0002, Japan

PHONE +81-6-6791-6781

FAX +81-6-6793-1221

MAIN OFFICE EUROPE

DIJET GmbH

Immermannstraße 9

40210 Düsseldorf, Germany

PHONE +49-211-5008820

FAX +49-211-5008823

www.dijet.de



dijet europe



DIJET GmbH

Web : www.dijet.de